

DATI TECNICI

Potenza termica globale (max. - min.)	13,4 - 3,6 kW	Depressione canna fumaria (max. - min.)	11,9 - 10 Pa
Potenza nominale (max. - min.)	12,1 - 3,3 kW	Peso	129 kg
Rendimento (max. - min.)	90 - 93,4 %	Dimensioni LxPxH	490x503x1073 mm
Temperatura dei fumi (max. - min.)	191,1 - 96 °C	Dimensione uscita fumi	ø 80 mm
Capacità serbatoio pellet	25 kg	Uscita fumi	Posteriore
Consumo orario (max. - min.)	2,7 - 0,72 kg/h		
Volume riscaldabile (indicativo)	340 m³		
Autonomia (max. - min.)	9,26 - 34,7 h		
Emissioni CO (13% O ₂) (max. - min.)	155 - 673 mg/m³		
Emissioni NOx (13% O ₂) (max. - min.)	126 - 123 mg/m³		
Emissioni OGC (13% O ₂) (max. - min.)	2 - 6 mg/m³		
Emissioni polveri (13% O ₂) (max. - min.)	17,7 - 49,7 mg/m³		
Massa fumi (max. - min.)	6,6 - 2,7 g/s		

DOTAZIONI

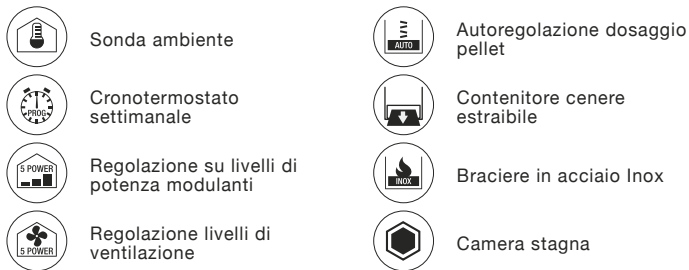

OPTIONAL



DIMENSIONI ED INGOMBRI

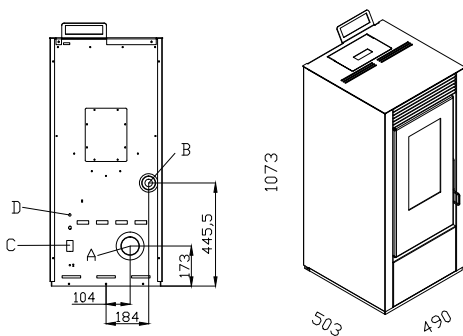

- A** Scarico fumi ø 80 mm
- B** Aspirazione aria ø 60 mm
- C** Interruttore on/off
- D** Termostato a riarmo manuale

CERTIFICAZIONI

EN 14785:2006	German BIMSchv	Flamme Verte (7 stars)
Austrian 15a B-VG	Swiss TRV Limits	

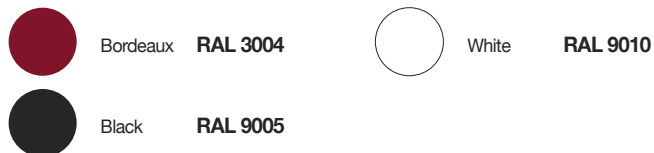

TECHNICAL DATA

Total heat input (max. - min.)	13,4 - 3,6 kW	Average flue draught (max. - min.)	11,9 - 10 Pa
Nominal heat output (max. - min.)	12,1 - 3,3 kW	Weight	129 kg
Efficiency (max. - min.)	90 - 93,4 %	Dimensions LxPxH	490x503x1073 mm
Flue gas temperature (max. - min.)	191,1 - 96 °C	Smoke outlet dimensions	ø 80 mm
Hopper capacity	25 kg	Smoke outlet	Rear exhaust
Hourly consumption (max. - min.)	2,7 - 0,72 kg/h		
Heating volume	340 m³		
Autonomy (max. - min.)	9,26 - 34,7 h		
Emissions CO (13% O ₂) (max. - min.)	155 - 673 mg/m³		
Emissions NOx (13% O ₂) (max. - min.)	126 - 123 mg/m³		
Emissions OGC (13% O ₂) (max. - min.)	2 - 6 mg/m³		
Dust emissions (13% O ₂) (max. - min.)	17,7 - 49,7 mg/m³		
Flue gas mass flow (max. - min.)	6,6 - 2,7 g/s		

DEVICES

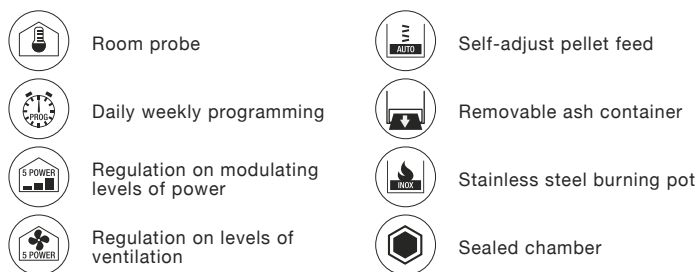

OPTIONAL



DIMENSIONS

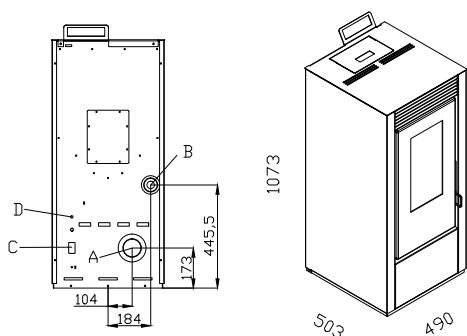

- A** Smoke outlet ø 80 mm
- B** External air inlet ø 60 mm
- C** Electric socket
- D** Manual reset thermostat

CERTIFICATIONS

EN 14785:2006

German BIMSChv

Flamme Verte (7 stars)

Austrian 15a B-VG

Swiss TRV Limits

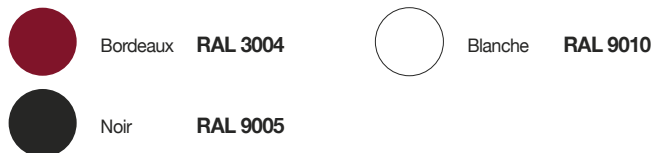

DONNÉES TECHNIQUES

Puissance thermique globale (max. - min.)	13,4 - 3,6 kW	Dépression cheminée (max. - min.)	11,9 - 10 Pa
Puissance thermique nominale(max. - min.)	12,1 - 3,3 kW	Poids	129 kg
Rendement (max. - min.)	90 - 93,4 %	Dimensions LxPxH	490x503x1073 mm
Température des fumées (max. - min.)	191,1 - 96 °C	Sortie de fumée	ø 80 mm
Capacité réservoir	25 kg	Sortie de fumée	Sortie postérieure
Consommation horaire (max. - min.)	2,7 - 0,72 kg/h		
Capacité de chauffe	340 m³		
Autonomie (max. - min.)	9,26 - 34,7 h		
Emissions CO (13% O ₂) (max. - min.)	155 - 673 mg/m³		
Emissions NOx (13% O ₂) (max. - min.)	126 - 123 mg/m³		
Emissions OGC (13% O ₂) (max. - min.)	2 - 6 mg/m³		
Emissions poussières (13% O ₂) (max. - min.)	17,7 - 49,7 mg/m³		
Débit de fumées (max. - min.)	6,6 - 2,7 g/s		

EQUIPEMENT



OPTIONAL



DIMENSIONS

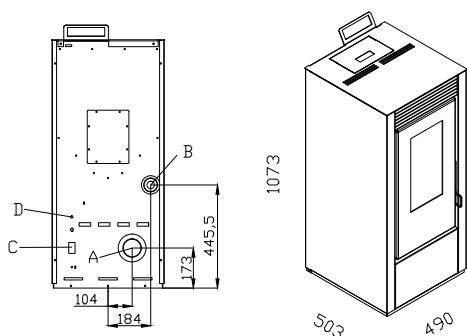

- A** Évacuation fumées ø 80 mm
- B** Prise d'aire comburant ø 60 mm
- C** Interrupteur
- D** Thermostat à réarmement manuel

CERTIFICATIONS

EN 14785:2006	German BIMSChv	Flamme Verte (7 stars)
Austrian 15a B-VG	Swiss TRV Limits	

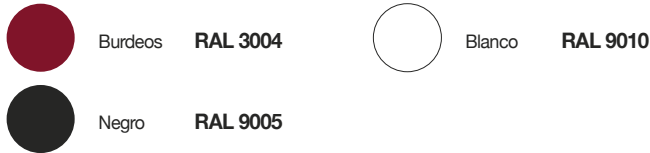

DATOS TÉCNICOS

Potencia térmica total (max. - min.)	13,4 - 3,6 kW	Tiro de la chimenea (max. - min.)	11,9 - 10 Pa
Potencia térmica nominal (max. - min.)	12,1 - 3,3 kW	Peso	129 kg
Rendimiento (max. - min.)	90 - 93,4 %	Dimensiones LxPxH	490x503x1073 mm
Temperatura de los humos (max. - min.)	191,1 - 96 °C	Dimensiones salida humos	ø 80 mm
Capacidad depósito de pellets	25 kg	Salida humos	Salida posterior
Consumo horario (max. - min.)	2,7 - 0,72 kg/h		
Volumen de calentamiento	340 m³		
Autonomía (max. - min.)	9,26 - 34,7 h		
Emisiones CO (13% O ₂) (max. - min.)	155 - 673 mg/m³		
Emisiones NOx (13% O ₂) (max. - min.)	126 - 123 mg/m³		
Emisiones OGC (13% O ₂) (max. - min.)	2 - 6 mg/m³		
Emisiones polvo (13% O ₂) (max. - min.)	17,7 - 49,7 mg/m³		
Masa de humos (max. - min.)	6,6 - 2,7 g/s		

EQUIPAMIENTO



OPTIONAL



DIMENSIONES

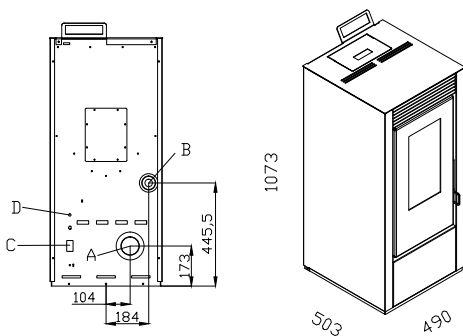

- A** Salida de humos ø 80 mm
- B** Aspiración de aire ø 60 mm
- C** Interruptor
- D** Termostato a rearme manual

CERTIFICACIONES

EN 14785:2006	German BIMSchv	Flamme Verte (7 stars)
Austrian 15a B-VG	Swiss TRV Limits	

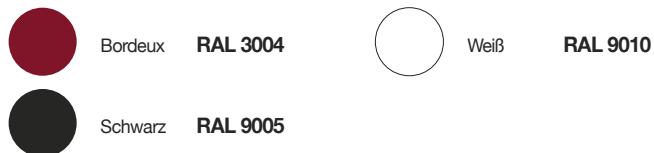

TECHNISCHE DATEN

Brennstoffwärmeleistun (max. - min.)	13,4 - 3,6 kW	Mindestförderdruck (max. - min.)	11,9 - 10 Pa
Nennwärmeleistung (max. - min.)	12,1 - 3,3 kW	Gewicht	129 kg
Wirkungsgrad (max. - min.)	90 - 93,4 %	BemaßungLxPxH	490x503x1073 mm
Abgastemperatur (max. - min.)	191,1 - 96 °C	Rauchabzug	ø 80 mm
Inhalt Pelletbehälter	25 kg	Rauchabzug	Abgasstutzen Hinten
Stundenverbrauch (max. - min.)	2,7 - 0,72 kg/h		
Raumheizvermöge	340 m³		
Betriebsautonomie (max. - min.)	9,26 - 34,7 h		
Emissionen CO (13% O ₂) (max. - min.)	155 - 673 mg/m³		
Emissionen NOx (13% O ₂) (max. - min.)	126 - 123 mg/m³		
Emissionen OGC (13% O ₂) (max. - min.)	2 - 6 mg/m³		
Feinstaubinhalt (13% O ₂) (max. - min.)	17,7 - 49,7 mg/m³		
Abgasmassenstrom (max. - min.)	6,6 - 2,7 g/s		

AUSRÜSTUNG



OPTIONAL



GRÖSSE

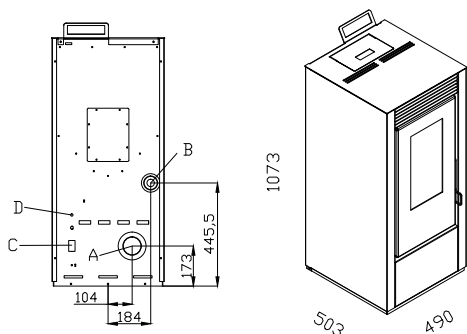

- A Rauchabzug ø 80 mm
- B Öffnungen für die Verbrennungsluft ø 60 mm
- C Hauptschalter
- D Manueller Thermostat zurücksetzen

ZERTIFIZIERUNGEN

EN 14785:2006

German BIMSChv

Flamme Verte (7 stars)

Austrian 15a B-VG

Swiss TRV Limits

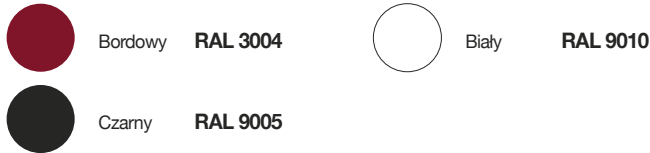

DANE TECHNICZNE

Wprowadzona moc cieplna (max. - min.)	13,4 - 3,6 kW	Ciąg kominowy (max. - min.)	11,9 - 10 Pa
Moc grzewcza całkowita (max. - min.)	12,1 - 3,3 kW	Waga	129 kg
Sprawność (max. - min.)	90 - 93,4 %	Wymiary LxPxH	490x503x1073 mm
Średnia temperatura spalin (max. - min.)	191,1 - 96 °C	Ujście dymu	ø 80 mm
Pojemność zbiornika	25 kg	Ujście dymu	Wylot spalin tylny
Zużycie paliwa moc (max. - min.)	2,7 - 0,72 kg/h		
Objętość ogrzewalna (indicativo)	340 m³		
Autonomia pracy (max. - min.)	9,26 - 34,7 h		
Emisja CO (13% O ₂) (max. - min.)	155 - 673 mg/m³		
Emisja NOx (13% O ₂) (max. - min.)	126 - 123 mg/m³		
Emisja OGC (13% O ₂) (max. - min.)	2 - 6 mg/m³		
Emisja pyłu (13% O ₂) (max. - min.)	17,7 - 49,7 mg/m³		
Masowy przepływ oparów (max. - min.)	6,6 - 2,7 g/s		

EQUIPAMIENTO



OPTIONAL



WYMIARY

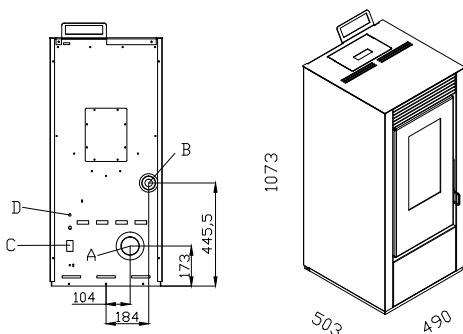

- A** Ujście dymu ø 80 mm
- B** Chwyt powietrza do spalania ø 60 mm
- C** Wyłącznikiem
- D** Termostat z ręcznym resetem

CERTYFIKATY

EN 14785:2006	German BIMSChv	Flamme Verte (7 stars)
Austrian 15a B-VG	Swiss TRV Limits	